



Professional
Reliable
Safe

EagleVision Net

Speeddome IP IR 250m - 25X/30X/45X - 2 ou 4MP - Análise de Vídeo - H265

SONY **STARVIS** Outstanding **Vis**ibility under the **Star**light



IP Speeddome IR
Análise de Vídeo
WDR Real 120dB
Super Low-Light

- Velocidade de transmissão em 60fps @ 1920 x 1080 pixels ou 30fps@4MP
- Zoom ótico de 25X, 30X ou 45X / 16X Zoom Digital
- Sensor Sony Starvis Super Low-Light
- 300 pre-sets controlados via teclado ou software
- Função *Deep-learning* para proteção perimetral e auto-tracking
- Funções Wide Dynamic Range (WDR) 120dB e 3D-DNR com Processamento Espacial para eliminação de ruído na imagem; Detecção de Movimento
- 24 máscaras de privacidade configuráveis
- Compressão de vídeo H265+, são duas vezes mais eficiente que seu antecessor H264, pois utiliza apenas 50% da largura de banda, e mantém a mesma qualidade da compressão H.264
- Controle de banda em rede LAN/WAN integrado (56kbs~16Mbs)
- Segurança avançada: Filtro IP, HTTPS, 802.1X e SSL
- Função *Ultra Fast Pan/Tilt* em até 300°/s em modo preset
- Análise de vídeo: Detecção Facial, Cerca Virtual, Proteção Perimetral, Objeto Abandonado / roubado, Detecção de pessoas e veículos, etc
- Atualização de software e firmware via FTP Web ou via site da EagleVision



Auto-tracking integrado

Baixa Luminosidade em até 0.0/Lux

WDR Real em 120dB, 3D-DNR, BLC, ICR, AWB, AGC, DSS, Detecção de Movimento, Máscara Privada, etc

Interface SD/SDHC integrada

Multi-stream possibilita configurar gravação e transmissão independente

Visão noturna em até 250 metros

Anti-vandalismo IK10

Suporta temperature -40°C ~ 70°C

Agenda de programação de horários para efetuar funções tais como: Scan, Ronda, Pre-sets, Alarme, etc

Proteção IP67 - NEMA-4X - IK10

Compatível com Digifort, Genetec, EagleCMS, DGuard, SDK e API para integração com outros Softwares

Garantia de 2 anos com suporte técnico nacional. Garantia estendida de 3 à 5 anos opcional





Professional
Reliable
Safe

EagleVision Net

SECURITY SOLUTIONS AND TECHNOLOGIES

SpeedDome IP Mega-Pixel IVA Externa e Interna

- Ferramentas de gerenciamento baseado em SNMP.
- Acesso de até 20 usuários via Unicast ou ilimitado via Multicast.
- Compressão de vídeo H265+, H264+, H264, MJPEG e JPEG
- Áudio bi-direcional integrado
- 7 entradas e 2 saídas de alarmes externos.
- 300 predefinições configuráveis, auto-percurso, auto-scan
- Proteção IP67 com aquecedor e ventilador embutidos
- Filtro IP pré-definidos para restringir acesso
- Proteção Anti-Vandalismo IK10
- Certificados ISO9001, CE, FCC, ROHS e RoHS
- Garantia de 2 (dois) anos contra defeito de fabricação (3 à 5 opcional)

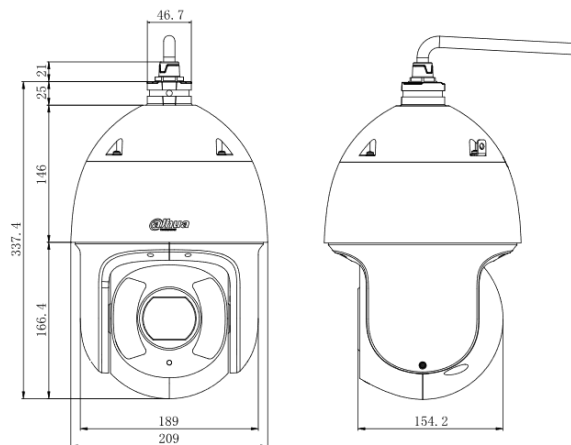

Pendant mount

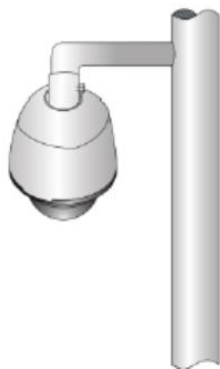

Standing pole mount

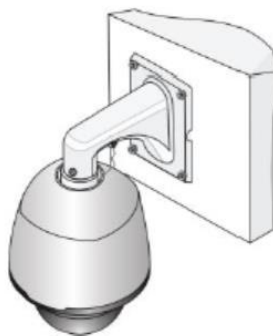

Wall mount

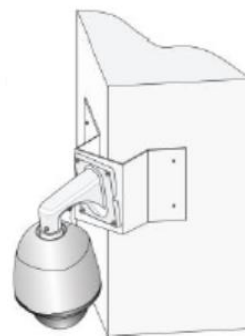

Corner mount

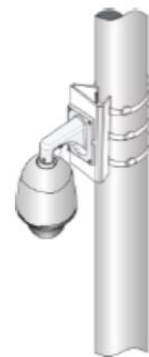

Pole mount



O H.265 é um formato de compressão de vídeo duas vezes mais eficiente que seu antecessor, pois utiliza apenas 50% da largura de banda, mantendo a mesma qualidade do H.264

[Conventional compression format]

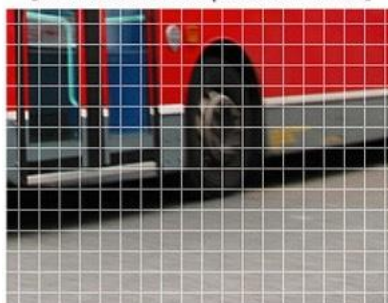

[Newly developed compression format]

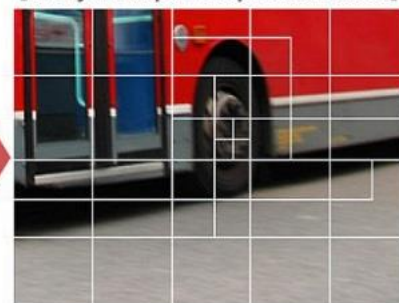

*Videos shown are rendered images.

Solução IP Mega-Pixel 45X • Ultra DNR • Análise de Vídeo Inteligente • WDR • 300 Presets • Máscara Privada • IP67 NEMA4X



Avenida do Batel, 1230 • 5º andar
Bairro Batel • Curitiba • PR • 80420-090
Tel: (041) 3342 1600 • vendas@eaglevision.com.br
www.eaglevision.com.br



Análise de Vídeo Inteligente

Intrusão, Objeto Roubadado/Abandonado, Proteção Perimetral, Estacionamento Ilegal, Monitoração de Área Restrita, etc.

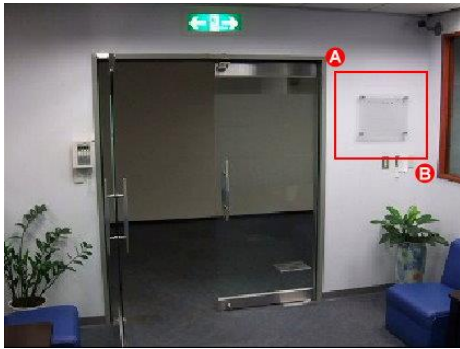

Detecção Objeto Roubadado
Monitora Objeto desaparecido na Imagem



Detecção Objeto Abandonado
Monitora Objeto Abandonado na Imagem



Proteção Perimetral
Monitora Perímetro Linear

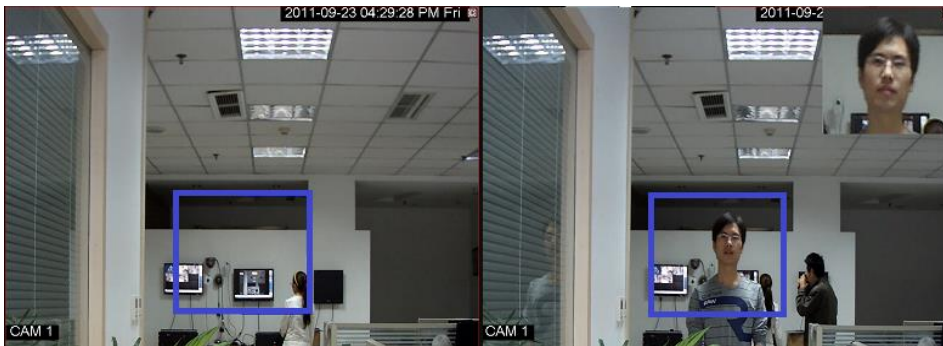

Detecção Facial (Integrado)
Monitora e Grava Faces Detectadas na Imagem

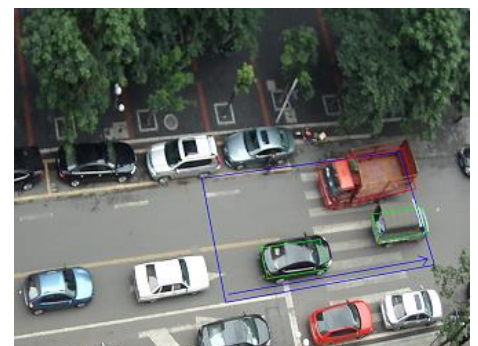

Estacionamento ilegal
Monitora Áreas de Estacionamento

Auto-Tracking Integrado

Monitora e efetua rastreamento automático de pessoas e veículos



Mapa de Calor

Monitora áreas de maior movimentação na imagem

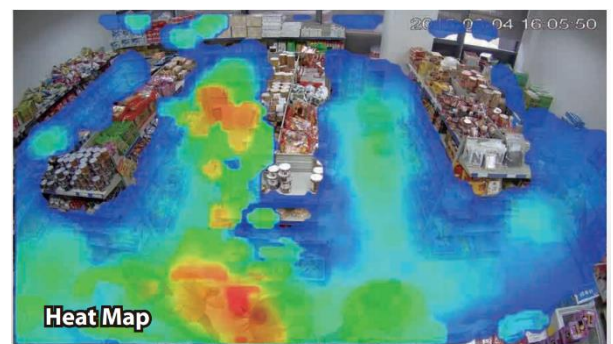



Powerful Solutions

Funções Avançadas para monitoração 24 horas: LowLight, Máscara Privada, 3D-DNR, WDR



3D-DNR – Redução de Ruído Digital na Imagem

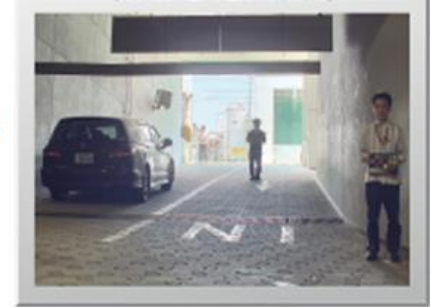
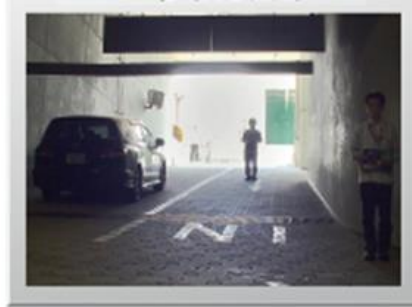

FUNÇÃO WDR (Possibilita melhor imagem compensando luz de fundo e frontal)

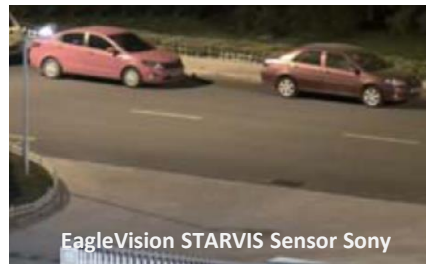

Starvis Sensor - Possibilita imagem colorida com qualidade mesmo em baixa luminosidade



Especificações Técnicas IP Speeddome Mega-Pixel EagleVision Net

Modelo	EN-SRDP225WP (25X, 2MP) - EN-SRDP425WP (25X, 4MP) Suporte de parede incluído (Outros opcionais) EN-SRDP230WP (30X, 2MP) - EN-SRDP430WP (30X, 4MP) Suporte de parede incluído (Outros opcionais) EN-SRDP245WP (45X, 2MP) - EN-SRDP445WP (45X, 4MP) Suporte de parede incluído (Outros opcionais)
Camera	
Image Sensor / Memory	1/1.8 SONY Starvis CMOS 4MP or 2MP - Memory RAM/ROM: 512Mb / 128Mb
Effective Pixels	1920(H)x1080(V), 2 Megapixels / 2560(H)x1440(V), 4 Megapixels
Electronic Shutter Speed	1/1 ~ 1/30,000s
Min. Illumination	Color: 0.002Lux@F1.4 50IRE, B/W: 0.0002Lux@F1.4 50IRE. 0.0Lux (IR ON)
S/N Ratio	More than 55dB
Camera Features	
Day/Night	Auto(ICR) / Color / B/W / 6x IR LED-ARRAY 250m range
Backlight Compensation	BLC / HLC / WDR (120dB)
White Balance	Auto, ATW, Indoor, Outdoor, Manual
Gain Control	Auto / Manual
Noise Reduction	Ultra 3D-DNR (3D Spatial processing)
Privacy Masking / Defog	Up to 24 areas / Defog function On / Off (better image during fog or smoke)
Other Functions	Digital Zoom 16x, Defog, ROI (Region of Interest), DIS (Digital Image Stabilizer), Firmware Update by network, Freeze Image Pre-set Mode, Tamper-proof, Focus/Scene change alarm, pre-se alarm link, Motion detection
Lens	
Focal Length	25X: H: 4.8mm~120mm F1.6~F4.4 - 30X: H: 4.5mm~135mm F1.6~F4.4 - 45X: 3.95mm~178mm F1.6 ~ F4.95
Focus/Iris Control	Auto and Manual
Angle of View	25X: H: 62.8° ~ 2.6° - 30X: H: 67.8° ~ 2.4 - 45X: H: 70.3° ~ 1.8°

Solução IP Mega-Pixel 45X • Ultra DNR • Análise de Vídeo Inteligente • WDR • 300 Presets • Máscara Privada • IP67 NEMA4X



Avenida do Batel, 1230 • 5º andar
Bairro Batel • Curitiba • PR • 80420-090
Tel: (041) 3342 1600 • vendas@eaglevision.com.br
www.eaglevision.com.br





Especificações Técnicas Speeddome IP Inteligente Mega-Pixel EagleVision Net

PTZ		
Pan/Tilt Range	Pan: 0° ~ 360° endless; Tilt: -20° ~ 90°, auto flip 180°	
Manual Control Speed	Pan: 0.01° ~ 260°/s; Tilt: 0.01° ~ 120°/s	
Preset Speed	Pan: 300°/s; Tilt: 200°/s	
Preset	300	
PTZ Mode	5 Pattern, 8 Tour, Auto Pan, Auto Scan	
Power up Action	Auto restore to previous PTZ and lens status after power failure	
Idle Motion	Activate Preset/Pan/Scan/Tour/Pattern if there is no command in the specified period	
Time Task	Auto activation of Preset/Pan/Scan/Tour/Pattern by preset-time	
Protocol	EagleVision, Pelco-P/D (Auto recognition)	
Video		
Compression	H265+ / H265 / H264+ / H264 / MJPEG / JPEG	
Resolution PAL/NTSC	4M(2560x1440) / 3M(2048x1536) / 2MP (1920x1080) / 720P(1280x720) / D1(704x576/704x480) / CIF	
Frame Rate (PAL/NTSC)	Main Stream	4M/3M(30fps) - 1080P/1.3M/ 720P(1~50/60fps)
	Sub Stream1	D1/CIF (1 ~ 25/30fps)
	Sub Stream2	1080P/720P/D1/CIF (1 ~ 25/30fps)
Bit Rate	H265/H.264: 56K ~ 8192Kbps, MPEG-4/MJPEG: 56K ~ 20480Kbps	
Audio		
Compression	G711a / G711Mu / AAC / G722 / G726 / G729 / MPEG2-L2	
Interface	1 channel In / 1 channel Out (600Ω)	
Intelligent Function		
Auto Tracking	Single-scene, multiple-scene, panorama-scene (Track people, cars, objects)	
IVS Intelligent Video	Face Detection, Tripwire, Cross Warning Zone, Perimeter Protection, Abandoned Object Detection, Missing Object Detection, Illegal Parking, Audio detection, Heat Map, Support alarm triggering by target types (human and vehicle) Filtering out false alarms caused by animals, rustling leaves, bright lights, etc..	
Face Detection	Detect face and keep record	
Tracking Mode/Event	Manual, Auto (alarm triggered) / Targeting, Zoom, Tracking, Recording, Snapshot, Alarm and etc.	
Network		
Ethernet	RJ-45 (10/100Base-T)	
Protocol	IPv4/IPv6, HTTP, HTTPS, SSL, TCP/IP, UDP, UPnP, ICMP, IGMP, RTCP, RTSP, RTP, SMTP, NTP, DHCP, DNS, ARP, PPPOE, DDNS, FTP, SNMPv1/v2c/v3, IP Filter, IEEE802.1x, QoS, Bonjour, P2P	
Compatibility	ONVIF S/G, PSIA, CGI, API	
Max. User Access	20 users	
Smart Phone Browsers	iPhone, iPad, Android, Windows Phone / IE9.0+, Firefox, Chrome, Safari	
Auxiliary Interface		
Edge Recording	NAS (Network Attached Storage), Local PC for instant recording, Micro SD/SDHC/SDXCcard (256GB Max)	
Alarm	7 input / 2 output integrated	
General		
Power Supply / Consumpton	AC24V/3A(±25%), PoE+(802.3at) / 17W, 22W(IR on)	
Working Environment	(-)40°C ~ 70°C / Less than 95% RH / Heater and Fan Integrated	
Ingress and Impact Protection	IP67, NEMA-4X / IK10 Vandal-proof	
Certification	ISO9001, CE, FCC, UL, ROHS	
Dimensions / Weight	Φ209(mm) x 337(mm) / 6.0kg	